

KRATOS

317-634-2550
kratosequip.com

SERVICE, INSTALLATION AND OPERATION MANUAL

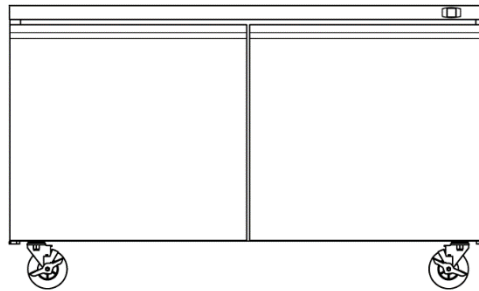
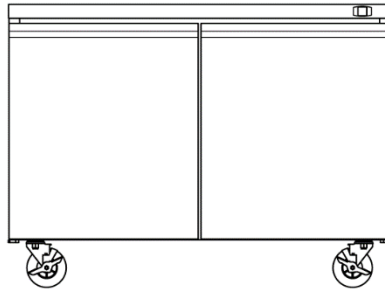
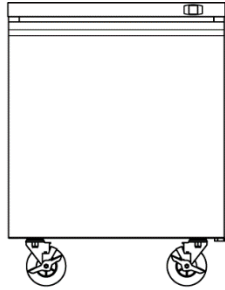

**For AUTHORIZED PARTS or TECHNICAL SERVICE, please contact:
1-887-368-2797**

7750 Georgetown Road, Indianapolis, IN 46268 USA
Phone: (317) 634-2550
Website: KratosEquip.com

**69K-767 W/1 DOOR
69K-768 W/2 DOOR
69K-752 W/2 DOOR
UNDERCOUNTER REFRIGERATORS
PLEASE READ CAREFULLY**

TABLE of CONTENTS

SERIAL NUMBER INFORMATION	3
APPLIANCE SAFETY	4
IMPORTANT SAFEGUARDS	5
DIMENSIONS	7
TECHNICAL INFORMATION	7
RECEIVING AND INSPECTING THE EQUIPMENT	8
INTRODUCTION	8
COMPONENT INFORMATION	9
APPLIANCE INSTALLATION	10
Remove Packaging Materials	10
Location Requirements	10
Inside cabinet:	10
Outside cabinet:	10
Installation Clearance	11
Leveling	11
Stabilizing	11
Electrical Connection	11
OPERATION	12
Refrigerated cycle	12
Power Switch:	12
SOLID-STATE THERMOSTAT DESCRIPTIONS	12
1. FRONT PANEL COMMANDS	12
2. MAIN FUNCTIONS	13
3. ALARM SIGNALLING	13
CLEANING AND MAINTENANCE	14
Exterior and Interior Cleaning of Appliances	14
Cleaning the Condenser Coil	14
Stainless Steel Care and Cleaning	15
Gasket Maintenance	15
Doors/Hinges	15
Drain Maintenance	15
TROUBLESHOOTING GUIDE	16
TROUBLESHOOTING	16
WIRING DIAGRAMS	17

VISIT OUR WEBSITE for the MOST UP-TO-DATE VERSION of this MANUAL.

<http://www.KratosEquip.com>

Fill out and return the enclosed warranty postcard or visit our website/warranty registration.
Keep the dated proof of purchase invoice which establishes the appliance's warranty period.

SERIAL #: _____

MODEL #: _____ **DATE OF PURCHASE:** _____

SERIAL NUMBER INFORMATION

- The serial number of all self-contained refrigerators is located inside the unit on the left hand side near the top on the wall.
- Always have the serial number of your unit available when calling for parts or service.
- This manual covers standard units only. If you have a custom unit, consult customer service department at the number listed on cover page.

**READ THIS MANUAL IN ITS ENTIRETY
TO HELP FAMILIARIZE YOURSELF WITH YOUR NEW EQUIPMENT BEFORE PROCEEDING.**
We have provided many important safety messages in this manual.
Always read and obey all safety messages.
Understanding of safety messages will assist in alerting you to potential hazards, as well as tell you
how to reduce the chance of injury. Follow the instructions as outlined in this manual.

Due to periodic changes in designs, methods, procedures, policies and regulations, the contents of this manual are subject to change without notice. While we exercise good faith efforts to provide information that is accurate, we are not responsible for errors or omissions in information provided or conclusions reached as a result of using this reference manual. By using the information provided, the user assumes all risks in connection with such use.

APPLIANCE SAFETY

Always read and obey all safety messages.



This is the Safety Alert Symbol. This symbol alerts you to potential hazards that can injure or kill you and others. All safety messages will follow the Safety Alert Symbol and either the words “**DANGER**”, “**WARNING**” OR “**CAUTION**”.

DANGER

DANGER means that failure to heed this safety statement may result in Death or Severe Personnel Injury.

WARNING

WARNING means that failure to heed this safety statement may result in extensive product damage, serious personal injury, or death.

CAUTION

CAUTION means that failure to heed this safety statement may result in minor or moderate personal injury, or property or equipment damage.

All safety messages will alert you to what the potential hazard is, tell you how to reduce the chance of injury, and let you know what can happen if the instructions are not followed.



NOTE: IMPORTANT SAFETY INSTRUCTIONS

WARNING

To reduce the risk of fire, electric shock or injury, when using your appliance, follow these basic precautions:

- Plug into a tested grounded 3-prong outlet.
- Do not remove grounding prong.
- Do not use an adapter.
- Do not use an extension cord.
- Disconnect power before cleaning.
- Disconnect power before servicing.
- Use 2 or more people to safely move and install appliance.

SAVE THESE INSTRUCTIONS

IMPORTANT SAFEGUARDS



Before the appliance is used, it must be properly positioned and installed as described in this manual, so read the manual carefully. We strongly recommend that you have a professional install your new machine. The warranty may be affected or voided by an incorrect installation. To reduce the risk of fire, electrical shock or injury when using the appliance, follow basic precautions, including the following:

DANGER

- It is recommended that a separate circuit, serving only your appliance, be provided. Use receptacles that cannot be turned off by a switch or pull chain.
- Please ensure that the required voltage is being supplied at all times.
- The unit should be plugged into a grounded and properly-sized electrical outlet with appropriate over-current protection.
- Ensure unit is not resting on, pinching or against the electrical cord.
- Do not connect or disconnect the electric plug when your hands are wet.
- Never unplug the appliance by pulling on the power cord. Always grip the plug firmly and pull straight out from the outlet.
- Never clean appliance parts with flammable fluids. Do not store or use gasoline or other flammable vapors and liquids in the vicinity of this or any other appliance. The fumes can create a fire hazard or explosion.
- Before proceeding with cleaning and maintenance operations, make sure the power line of the unit is disconnected.
- Unplug the appliance or disconnect power before cleaning or servicing. Failure to do so can result in electrical shock or death.
- If the unit is not in use for a long period of time, best to unplug the unit from the outlet.
- After unplugging the unit, wait at least 8 minutes before plugging it back in. Failure to do so could cause damage to the compressor.
- If the power cuts off, wait at least 8 minutes before turning the unit on to avoid damage to the compressor.
- Do not attempt to repair or replace any part of your appliance unless it is specifically recommended in this manual. A qualified technician should do all other servicing or repairs.

WARNING

- Use two or more people to move and install appliance. Failure to do so can result in back or other injury.
- This appliance must be properly installed and located in accordance with the Installation Instructions before it is used.
- Do not touch the cold surfaces in the cold compartment when hands are damp or wet. Skin may stick to these extremely cold surfaces.
- Setting temperature controls to the ZERO (0) position does not remove power to the light circuit, perimeter heaters, or evaporator fans.
- To ensure proper ventilation for your appliance, choose a well-ventilated area with temperatures above 50°F (10°C) and below 100°F (38°C). This unit **MUST** be installed in an area protected from the elements, such as wind, rain, water spray or drips.
- The appliance should not be located next to ovens, grills or other sources of high heat.
- It is important for the appliance to be level for proper operation. You may need to make adjustments to level it.
- Remove the packing materials and clean the appliance before using.
- Do not use this apparatus for other than its intended purpose.

IMPORTANT SAFEGUARDS (cont.)

Electrical Connection

Do not, under any circumstances, cut or remove the third (ground) prong from the power cord. For personal safety, this appliance must be properly grounded. The power cord of this appliance is equipped with a 3-prong grounding plug that mates with a standard 3-prong grounding wall outlet to minimize the possibility of electric shock hazard from the appliance. Have the wall outlet and circuit checked by a qualified electrician to make sure the outlet is properly grounded. The appliance should always be plugged into its own individual electrical outlet which has a voltage rating that matches the rating label on the appliance. This provides the best performance and also prevents overloading house wiring circuits which could cause a fire hazard from overheated wires. Repair or replace immediately all power cords that have become frayed or otherwise damaged. Do not use a cord that shows cracks or abrasion damage along its length or at either end. When moving the appliance, be careful not to damage the power cord.

Refrigerant Disposal

If you are throwing away your old appliance it may have a cooling system that uses "Ozone Depleting" chemicals. Make sure the refrigerant is removed for proper legal disposal by a qualified service technician.

DIMENSIONS

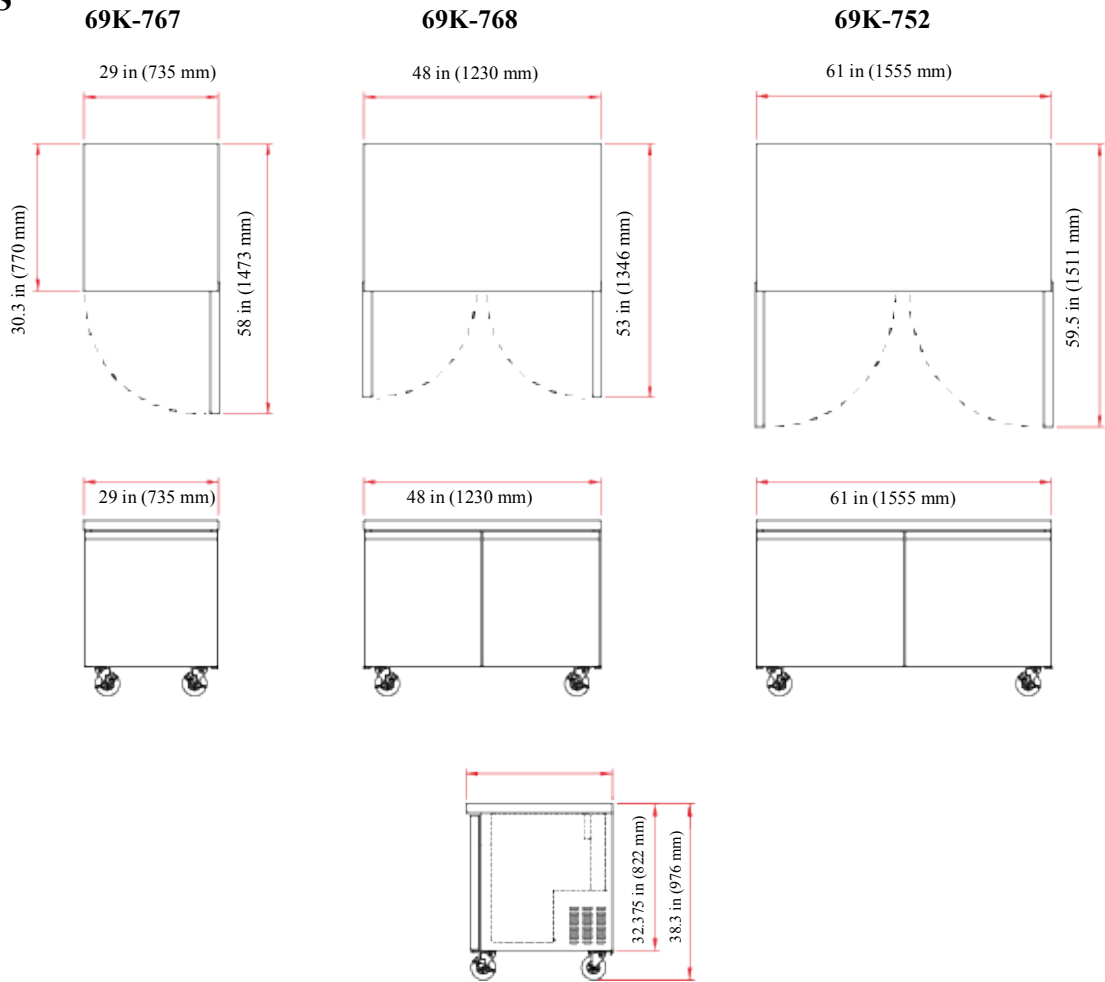

TECHNICAL INFORMATION

Model	69K-767	69K-768	69K-752
in: Exterior Dimension W*D*H	29 x 30.3 x 38.3	48 x 30.3 x 38.3	61 x 30.3 x 38.3
mm: Exterior Dimension W*D*H	735 x 770 x 976	1230 x 770 x 976	1555 x 770 x 976
in: Depth With Door(s) Open	58	53	59.5
mm: Depth With Door(s) Open	1473	1346	1511
in: Interior Dimensions W*D*H	24 x 23.4 x 26.6	43 x 23.4 x 26.6	56 x 23.4 x 26.6
mm: Interior Dimensions W*D*H	610 x 636 x 676	1105 x 636 x 676	1430 x 636 x 676
Nominal Capacity	6.7 Cu Ft / 190 L	11.1 Cu Ft / 314 L	14.1 Cu Ft / 399 L
Appliance Weight	143 lbs / 65 kg	242 lbs / 110 kg	265 lbs / 120 kg
Hinged Doors	1	2	2
Shelves	1	2	2
Electrical Service	115V/60Hz/1Ph	115V/60Hz/1Ph	115V/60Hz/1Ph
Wattage	264	357	406
Average Amp Draw	3.6	4.3	5.6
Refrigerant	R290	R290	R290
Provided 6' NEMA Cord Set	5-15	5-15	5-15

RECEIVING AND INSPECTING THE EQUIPMENT

Even though most equipment is shipped crated, care should be taken during unloading so the equipment is not damaged while being moved into the building.

1. Visually inspect the exterior of the package and skid or container. Any damage should be noted and formally reported to the delivering carrier as soon as possible within 10 days.
2. If damaged, open and inspect the contents with the carrier.
3. In the event that the exterior is not damaged, yet upon opening, there is concealed damage to the equipment, notify the carrier. Notification should be made verbally as well as in written form.
4. Request an inspection by the shipping company of the damaged equipment. This should be done within 10 days from receipt of the equipment.
5. Be certain to check the compressor compartment housing and visually inspect the refrigeration package. Be sure lines are secure and base is still intact.
6. Freight carriers can supply the necessary damage forms upon request.
7. Retain all crating material until an inspection has been made or waived.

INTRODUCTION

This user's manual is intended for installing, using and servicing your Kratos Appliance. It is recommended that this manual be kept in an accessible place. Every Kratos machine is designed and manufactured according to the highest standards of safety and performance. It meets or exceeds the safety standard of UL 471 and sanitation standard NSF 7.

Kratos assumes no liability or responsibility of any kind for products manufactured by Kratos, that have been altered in any way, including the use of any parts and/or other components not specifically approved by the manufacturer. Kratos reserves the right to make design changes and/or improvements at any time. Specifications and designs are subject to change without notice.

COMPONENT INFORMATION

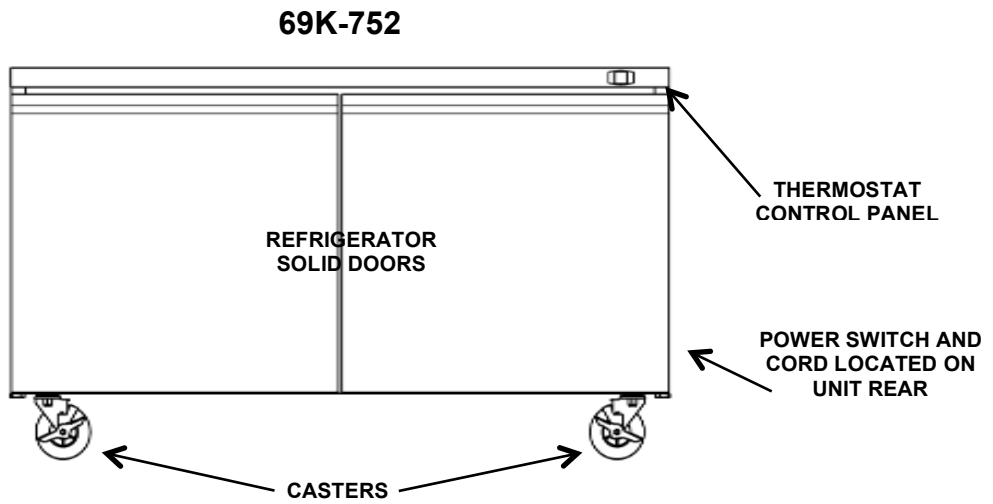
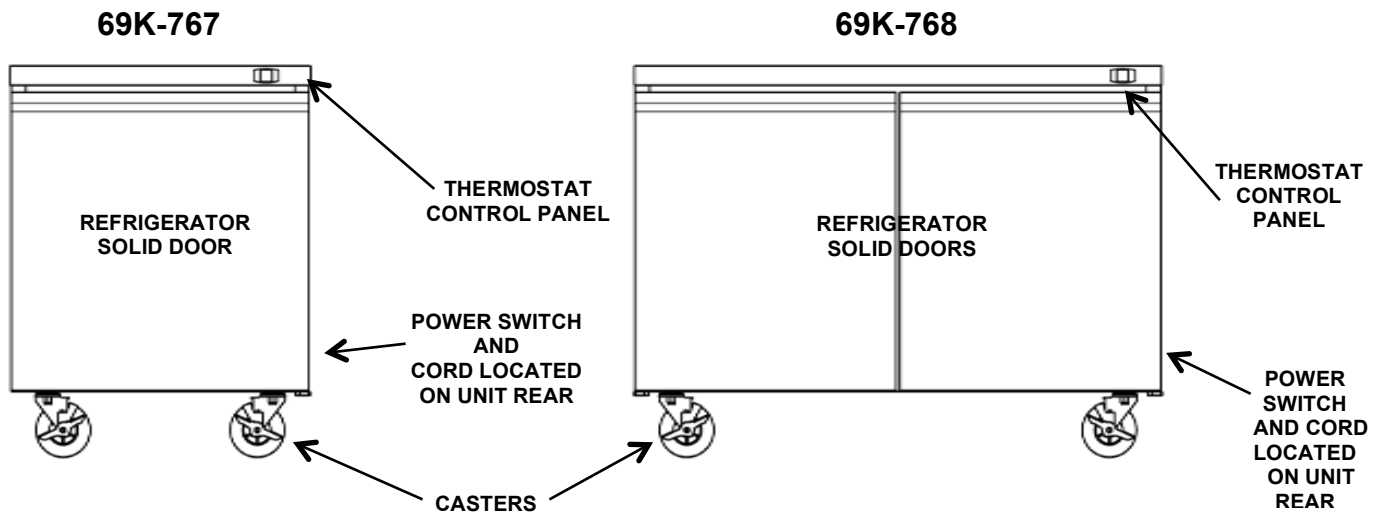

APPLIANCE INSTALLATION

WARNING

Excessive Weight Hazard

Use two or more persons to move and install appliances.
Failure to do so may result in back or other injury.

Remove Packaging Materials

IMPORTANT:

Do not remove any permanent instruction labels or the data label on your appliance.

- Remove tape and glue from your appliance before using.
- To remove any remaining tape or glue, rub the area briskly with your thumb. Tape or glue residue can also be easily removed by rubbing a small amount of liquid dish soap over the adhesive with your fingers. Wipe with warm water and dry with a soft cloth.
- Do not use sharp instruments, rubbing alcohol, flammable fluids, or abrasive cleaners to remove tape or glue. These products can damage the surface of your appliance.

NOTICE:

LOSS OR SPOILAGE OF PRODUCTS IN YOUR APPLIANCE IS NOT COVERED BY WARRANTY. IN ADDITION TO FOLLOWING RECOMMENDED INSTALLATION PROCEDURES. PLEASE RUN THE APPLIANCE 24 HOURS PRIOR TO USAGE.

Location Requirements

- Appliances represented in this manual are intended for indoor use only.
- Be sure the location chosen has a floor strong enough to support the total weight of the cabinet and contents as a fully loaded unit can weigh as much as 800 pounds.
- Reinforce the floor as necessary to provide for maximum loading.
- For the most efficient refrigeration, be sure to provide good air circulation inside and out.

Inside cabinet:

Do not pack the units so full that air cannot circulate. The refrigerated air is discharged at the top rear of the unit. It is important to allow for proper air flow from the top rear to the bottom of the unit. Obstructions to this air flow can cause evaporator coil freeze ups and loss of temperature or overflow of water from the evaporator drain pan. The shelves have a rear turn up on them to prevent this. However, bags and other items can still be located to the far rear of the cabinet. Air is brought into the evaporator coil with fans mounted to the front of the coil.

Outside cabinet:

Be sure that the unit has access to ample air. Avoid hot corners and locations near stoves and ovens.

It is recommended that the unit be installed no closer than 2" (51mm) from any wall and a max door swing clearance of 60.5 in. (1537mm).

APPLIANCE INSTALLATION (cont.)

Installation Clearance

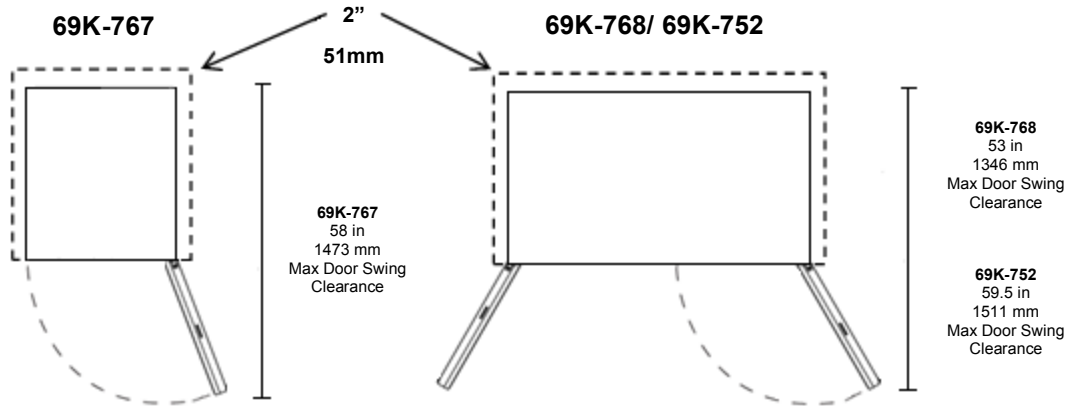

Leveling

Ensure the floor where the unit is to be located is level or shim the unit to level it.

Stabilizing

All models are supplied with casters for your convenience. It is very important, however, that the cabinet be installed in a stable condition with the front wheels locked while in use. Should it become necessary to lay the unit on its side or back for any reason, allow at least 24 hours before start-up to allow compressor oil to flow back into place. Failure to meet this requirement can cause compressor failure and unit damage, which would not be covered by your warranty.

NOTICE:

Unit repairs will not be subject to standard unit warranties if due to improper installation procedures.

Electrical Connection

Refer to the amperage data on the Technical Information table, the serial tag, your local code or the National Electrical Code to be sure that unit is connected to the proper power source.



DANGER

The unit must be turned OFF and disconnected from the power source whenever performing service, maintenance functions or cleaning the refrigerated area. Failure to comply may result in Death or Severe Personnel Injury.

OPERATION

Refrigerated cycle

Refrigerators: During the refrigeration cycle, the evaporator fans will run continuously even when one or more doors are open. The door switch will activate the lights when opened on solid door models only. Glass door models lights are turned on manually using a switch located next to the main power switch.

1. Every 6 hours, the unit will turn off and to allow the evaporator coil to air defrost. The controller now displays defrost symbol. When the coil temperature reaches 53°F (12°C) or after 30 minutes of defrost, the unit will turn on again.
2. Anti-condensation heaters on door frames work in conjunction with the compressor.
3. Recommended holding temperature range: 34° to 40°F (2° to 5°C).
4. Comes factory set to 39°F (4°C).

Power Switch:

The power switch is located on the front of the bottom panel. When the unit is on, the switch will glow green.

SOLID-STATE THERMOSTAT DESCRIPTIONS

1. FRONT PANEL COMMANDS



- SET:** To display target set point; in programming mode it selects a parameter or confirm an operation.
- To start a manual defrost.
- In programming mode it browses the parameter codes or increases the displayed value.
- In programming mode it browses the parameter codes or decreases the displayed value.

KEYS COMBINATION

- + To lock or unlock the keyboard.
- SET** + To enter in programming mode.
- SET** + To return to room temperature display.

1.1 Function of LEDS

LED	MODE	SIGNIFICANCE
	On	Compressor enabled
	Flashing	Anti short cycle delay enabled (AC parameter)
	On	Defrost in progress
	Flashing	Dripping in progress
	On	Fans output enabled
	Flashing	Fans delay after defrost
°C	On	Measurement unit
	Flashing	Programming mode
°F	On	Measurement unit
	Flashing	Programming mode



OPERATION (cont.)

2. MAIN FUNCTIONS

2.1 HOW TO SEE THE SET POINT

1. Push and immediately release the **SET** key, the set point will be showed;
2. Push and immediately release the **SET** key or wait about 5s to return to normal visualization.

2.2 HOW TO CHANGE THE SETPOINT



1. Push the SET key for more than 2 seconds to change the Set point value;
2. The value of the set point will be displayed and the “C” or “F” LED starts blinking;
3. To change the Set value push the  or  arrows.
4. To memorize the new set point value push the SET key again or wait 10s.

2.3 HOW TO START A MANUAL DEFFROST

Push the **DEF**  key for more than 2 seconds and a manual defrost will start





2.4 TO LOCK THE KEYBOARD

1. Keep pressed for more than 3s the  and  keys.
2. The “OF” message will be displayed and the keyboard will be locked. If a key is pressed more than 3s the “OF” message will be displayed.



2.5 TO UNLOCK THE KEYBOARD

Keep pressed together for more than 3s the  and  keys till the “on” message will be displayed.

3. ALARM SIGNALLING

Mess.	Cause	Outputs
"P1"	Room probe failure	Compressor output according to "Cy" e "Cn"
"P2"	Evaporator probe failure	Defrost end is timed
"HA"	Maximum temperature alarm	Outputs unchanged
"LA"	Minimum temperature alarm	Outputs unchanged
"EA"	External alarm	Outputs unchanged
"CA"	Serious external alarm	All outputs OFF
"dA"	Door Open	Compressor and fans restarts

3.1. ALARM RECOVERY

Probe alarms **P1** and **P2** start some seconds after the fault in the related probe; they automatically stop some seconds after the probe restarts normal operation. Check connections before replacing the probe. Temperature alarms **HA** and **LA** automatically stop as soon as the temperature returns to normal values.

Alarms **EA** and **CA** (with iF=bL) recover as soon as the digital input is disabled.

CLEANING AND MAINTENANCE



DANGER

The unit must be turned off and disconnected from the power source whenever performing service, maintenance functions or cleaning the refrigerated area. Failure to comply may result in death or severe personnel injury.

Exterior and Interior Cleaning of Appliances

Clean using soap and warm water. If this isn't sufficient, try ammonia and water or a nonabrasive liquid cleaner. When cleaning the exterior, always rub with the "grain" of the stainless steel to avoid marring the finish.

- Do not use an abrasive cleaner because it will scratch the stainless steel and plastic and can damage the breaker strips and gaskets.

Cleaning the Condenser Coil

Regular cleaning is recommended every 90 days. In some instances, you may find that there is a large amount of debris and dust or grease accumulated prior to the 90 day time frame. In these cases the condenser coil should be cleaned every 30 days.

If the buildup on the coil consists of only light dust and debris, the condenser coil can be cleaned with a simple brush. Heavier dust build-up may require a vacuum or even compressed air to blow through the condenser coil.

If heavy grease is present, there are de-greasing agents available for refrigeration use and specifically for the condenser coils. The condenser coil may require cleaning with the de-greasing agent and then blown through with compressed air.

Failure to maintain a clean condenser coil can initially cause high temperatures and excessive run times. Continuous operation with dirty or clogged condenser coils can result in compressor failures. Neglecting the condenser coil cleaning procedures will void any warranties associated with the compressor or cost to replace the compressor.

- For efficient operation, keep the condenser surface free of dust, dirt, and lint.
- We recommend cleaning the condenser coil at least once per month.
- Clean the condenser with a commercial condenser coil cleaner and a soft brush, available from any commercial refrigeration equipment retailer, or vacuuming the condenser with a shop vac or use CO₂.



CAUTION

Never use a high pressure water wash for this cleaning procedure as water can damage the electrical components located near or at the condenser coil.

In order to maintain proper refrigeration performance, the condenser fins must be cleaned of dust, dirt and grease regularly. It is recommended that this be done at least every three months. If conditions are such that the condenser is totally blocked in three months, the frequency of cleaning should be increased. Clean the condenser with a vacuum cleaner or stiff brush. If extremely dirty, a commercial-grade condenser cleaner may be required.

CLEANING AND MAINTENANCE (cont.)

Stainless Steel Care and Cleaning

To prevent rust or discoloration on stainless steel several important steps need to be taken. First, we need to understand the properties of stainless steel. Stainless steel contains 70-80% iron which will rust. It also contains 12-20% chromium which forms an invisible passive film over the steel's surface which acts as a shield against corrosion. As long as the protective layer is intact, the metal still resists oxidation. If the film is broken or contaminated, outside elements can begin to breakdown the steel and begin to form rust or discoloration.



CAUTION

Proper cleaning of stainless steel requires soft cloths or plastic scouring pads, never use steel pads, wire brushes or scrapers!

Cleaning solutions need to be alkaline based or non-chloride based. Any cleaner containing chlorides will damage the protective film of the stainless steel. If cleaners containing chlorides are used, be sure to rinse and dry thoroughly.

Routine cleaning of stainless steel can be done with soap and water. Extreme stains or grease should be cleaned with a non-abrasive cleaner and plastic scrub pad. It is always good to rub with the grain of the steel. There are also stainless steel cleaners available which can restore and preserve the finish of the steel's protective layer.

Early signs of stainless steel breakdown can consist of small pits and cracks. If this has begun, clean thoroughly and start to apply stainless steel cleaners in attempt to restore the passivity of the steel.



CAUTION

Never use an acid based cleaning solution! Many food products have an acidic content which can deteriorate the finish. Be sure to clean the stainless steel surfaces of all food products.

Gasket Maintenance

Gaskets require regular cleaning to prevent mold and mildew build up and also to keep the elasticity of the gasket. Gasket cleaning can be done with the use of warm soapy water. Avoid full strength cleaning products on gaskets. Do not use sharp tools or knives to scrape or clean the gasket.

Gaskets can easily be replaced and don't require the use of tools or authorized service technicians. The gaskets are "Dart" style and can be pulled out of the groove in the door and replaced by pressing the new one back into place.

Doors/Hinges

If the door is beginning to sag, tighten the screws that mount the hinge brackets to the frame of the unit. If the doors are loose or sagging, this can cause the hinge to pull out of the frame which may damage both doors and door hinges.

Drain Maintenance

Each unit has a drain located inside the unit which removes the condensation from the evaporator coil and evaporates it into an external condensate evaporator pan. The drain can become loose or disconnected. If you notice excessive water accumulation on the inside of the unit, be sure the drain tube is connected from the evaporator housing to the condensate evaporator drain pan.

If water starts to collect underneath the unit, check the condensate evaporator drain tube to be sure it is still located inside the drain pan.

If your floor is not level, this can also cause drain problems. Be sure all drain lines are free of obstructions because this may cause water to back up and overflow the drain pans.

TROUBLESHOOTING GUIDE

BEFORE CALLING FOR SERVICE

If the unit appears to be malfunctioning, read through the OPERATION section of this manual first. If the problem persists, see Troubleshooting below. The problem may be something very simple that can be solved without a service call.

TROUBLESHOOTING

Fault	Probable Cause	Action
Compressor is Not Running	Fuse blown or circuit breaker tripped	Replace fuse or reset circuit breaker. If replacement of fuse or reset of circuit breaker doesn't correct the problem contact a qualified service technician.
	Power cord unplugged	Plug in power cord
	Thermostat set too high	Set thermostat to lower temperature
Cabinet Temperature is too Warm	Thermostat is set too high	Set thermostat to lower temperature.
	Airflow is blocked	Re-arrange products to allow for proper air flow. Make sure there is at least four inches of clearance from the fan
	Low refrigerant levels	Contact a qualified service technician to check refrigerant levels
	Door is slightly ajar	Make sure door is completely closed.
Interior Light is Not Working	Poor switch connection	Turn off light switch and turn it back on.
	Bulb is not connected	Make sure the bulb is correctly inserted in the socket.
	Bulb has burned out	Replace the bulb. If replacement of bulb doesn't correct the problem contact a qualified service technician.
Condensation is Collecting on the Cabinet and/or Floor	Gasket is not sealing properly	Clean, repair, or replace the gasket as necessary

WIRING DIAGRAMS

MODEL: 69K-767

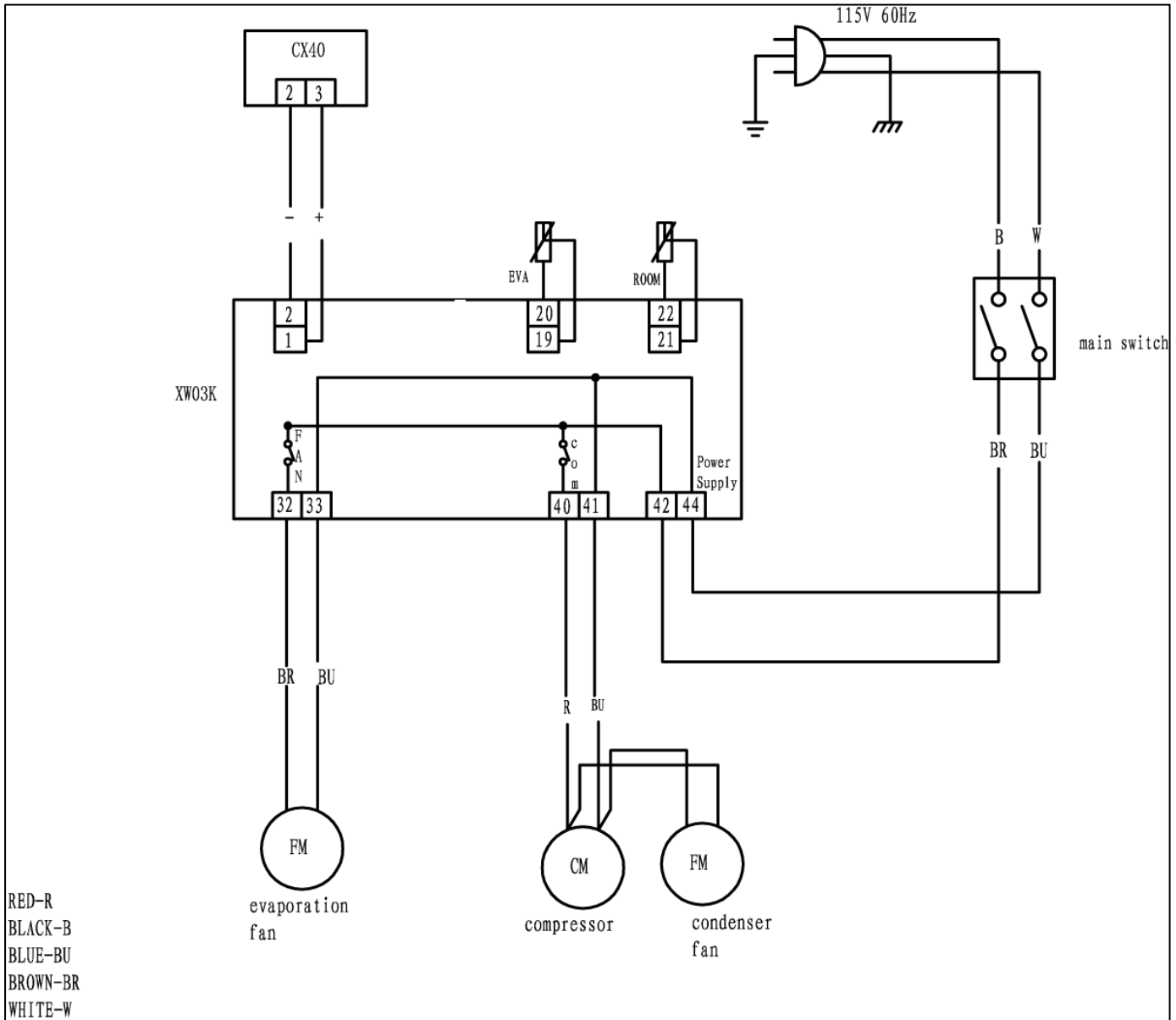

WIRING DIAGRAMS (cont.)

MODEL: 69K-768/69K-752

