



# BEVERAGE-AIR

PO Box 5932, Spartanburg, SC 29304  
1-888-845-9800 Fax# 1-864-582-5083  
<http://www.Beverage-Air.com>

## Commercial Refrigeration Equipment General Specification

### UCR/UCF—SERIES UNDERCOUNTER UNITS

Select from 4 standard sizes in widths of 46" (1 door), 67" (2 door), 93" (3 door), and 119" (4 door). Overall height is 34 1/2" with units installed on 6 inch casters (2 with brakes).

### CABINET CONSTRUCTION

Construction features include stainless steel exteriors and anodized aluminum interiors. Cabinet back and bottom are galvanized steel. Interiors accommodate sheet pans and hotel pans. Pan slides are optionally available.

Cabinets are insulated with 2" thick foamed-in-place polyurethane insulation. Doors are mounted to cabinet on self-closing, cartridge style hinges with 120° stay open feature. Doors are equipped with a snap-in-place vinyl magnetic gaskets for positive seal. Convenient, double pull style door handle is made of black anodized aluminum. 6" high casters are standard, 2 include brakes. An 8' cord set is provided with 115 volt models. Cabinet interior standard with 2 steel wire epoxy coated shelves per section. Interior light with manual switch is provided with glass door models.

### REFRIGERATION

Balanced refrigeration systems provide high humidity storage of product at 35° to 38°. One size undercounter freezer UCF67 holds product below zero and is equipped with time activated, temperature terminated, electric defrosting. Refrigerants include CFC free R134a in refrigerators and 404A in freezers to comply with all environmental standards.

### ELECTRICAL

Units wired at factory and ready for connection to a 115/60/1 phase, 15 amp dedicated outlet. 8' long cord and plug set included.

### SPECIAL FEATURES

- Cartridge style door hinges provides positive seal & eliminates door sagging issues (excludes glass door and some special units).
- Optional 6" legs or 3" casters available

Item No. \_\_\_\_\_

Quantity \_\_\_\_\_

## 32" DEPTH UNDERCOUNTER REFRIGERATORS AND FREEZER FOOD PREPARATION SERIES

MODELS:  
UCR46A  
UCR/UCF67A  
UCR93A  
UCR119A



UCR/UCF67



UCR93

### ELECTRICAL CONNECTION

Units pre-wired at factory and include 8' long cord and plug set.



Available From:



Model Specified \_\_\_\_\_

Store# \_\_\_\_\_

Location \_\_\_\_\_

Quantity \_\_\_\_\_



## Undercounter Refrigerators and Freezer

### 32" Base Model Series

Models: UCR46A / UCR67A / UCR93A / UCR119A / UCF67A

MODEL	UCR46A	UCR67A	UCR93A	UCR119	UCF67A
<b>EXTERNAL DIMENSIONAL DATA</b>					
Length Overall (inches)	46"	67"	93"	119"	67"
Length Overall (mm)	1168	1702	2362	3023	1702
Depth Overall (inches) - Less handle	32"	33 3/4"	33 7/8"	33 3/4"	33 3/4"
Depth Overall (mm) - Less handle	813	857	860	857	857
Height Overall—on 6" casters (inches)	34 1/2"	34 5/8"	32 1/4"	32 3/8"	34 5/8"
Height Overall—on 6" casters (mm)	876	880	819	822	880
Depth with Door Open 90°	55 3/8"	55 7/8"	57"	55 7/8"	57"
Clear Door Opening (inches)	21 1/2" x 23 1/2"	23 1/3" x 25 1/4"	21 1/2" x 23 1/2"	21 1/2" x 23 1/2"	21 1/2" x 23 1/2"
Number of doors	1	2	3	4	2
<b>INTERNAL DIMENSIONAL DATA</b>					
NET Capacity (cubic ft.)	6.2	19.21	29.7	40.5	19.21
NET Capacity (Liters)	175	544	841	1147	544
Internal Length Overall (inches)	22"	48"	74"	100 1/8"	48"
Internal Length Overall (mm)	559	1219	1880	2543	1219
Internal Depth Overall (inches)	26"	28"	28"	28"	28"
Internal Depth Overall (mm)	660	711	711	711	711
Internal Height Overall (inches)	23 1/2"	25"	24"	25 1/4"	25"
Internal Height Overall (mm)	597	635	610	641	635
Number of shelves	2	4	6	8	4
<b>ELECTRICAL DATA</b>					
Full Load Amperes 115/60/1	6.3	6.3	8.6	8.6	8.6
<b>ENERGY CONSUMPTION (KWH)</b>					
	2.81	2.56	3.49	3.91	15.3
<b>REFRIGERATION DATA</b>					
Horsepower	1/4	1/4	1/3	1/3	3/4
<b>WEIGHT DATA</b>					
Gross Weight (Crated lbs)	240	342	442	535	405
Gross Weight (Crated kg)	109	155	201	243	184

## PLAN VIEWS

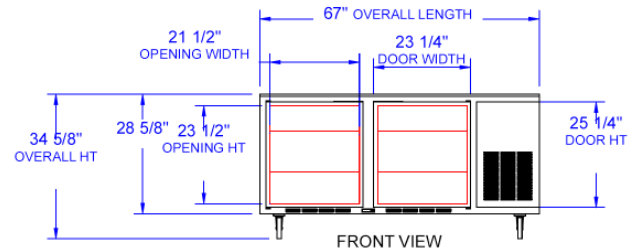
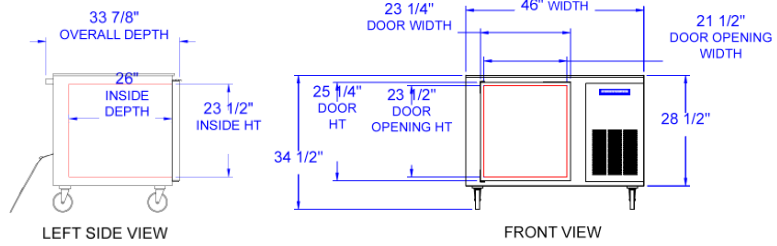

## UCR/UCF67

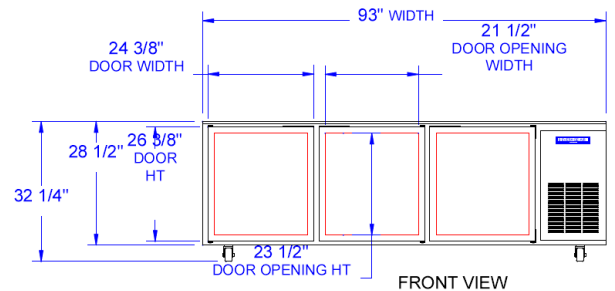
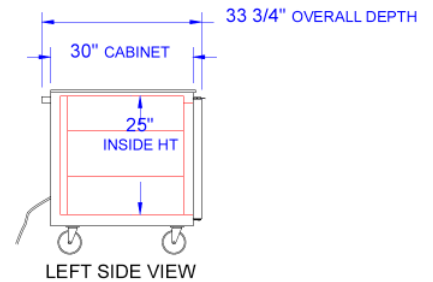

## UCR93

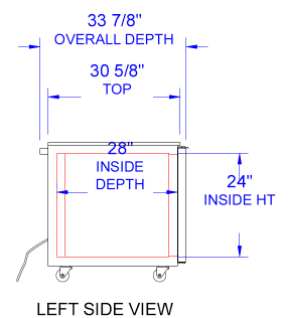

## UCR119

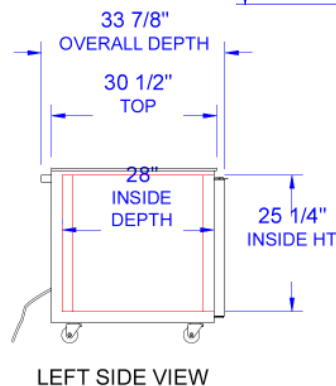
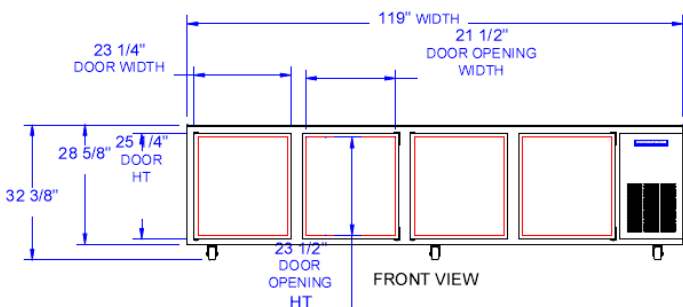

## BEVERAGE-AIR® CORPORATION

700 Buffington Road • PO Box 5932 • Spartanburg, SC 29304 USA • (864) 582-8111 • Fax (864) 582-5083 • (888) 845-9800 • www.beverage-air.com