



STAR® SELF CONTAINED REFRIGERATED COUNTERTOP SERVER MODEL: RCR4

Features/Benefits

- ★ Self-contained refrigeration system
- ★ NSF-7 Compliant at 35° F product temperature
- ★ Foamed-in-place insulation
- ★ Stainless steel front, top and sides
- ★ Includes 4-each removable 1/6th – size, 6” deep, clear polycarbonate inset pans with hinged lids
- ★ Accommodates equivalent 2/3rd-size, 1/3rd-size 1/6th-size or 1/9th-size pans
- ★ Sanitation approved for pans in depths from 2” to 6” deep
- ★ Includes adapter bar to support smaller fractional pans
- ★ Pans are easily removable for ease of cleaning
- ★ ½” rubber feet
- ★ 4’ cord & NEMA 5-15P plug with strain relief
- ★ 1/6-HP compressor @ 300 BTUH
- ★ R-134A Refrigerant
- ★ 120V, 60HZ
- ★ All 16 & 20 gage stainless steel inside & out
- ★ Features adjustable temperature controls with digital read-out and lighted on/off rocker switch



Model RCR4

Application:

RCR4 is a self-contained refrigerated counter top system that is designed to hold toppings, condiments, or practically any food at NSF-7 safe temperatures. The RCR4 includes cold-well refrigeration, foamed-in place insulation, stainless steel construction, 4 each easily removable pans, ½” feet and 4’ cord & plug.

Quality Construction:

RCR4 features all stainless steel exterior construction, 1/2” – rubber feet, 4’ cord & NEMA 5-15P plug with strain relief. Comes with 4-each easily removable 6”-deep 1/6th - size clear, polycarbonate inset pans with hinged lids and will accommodate any equivalent assortment of 2/3rd-size, 1/3rd – size, 1/6th –size or 1/9th –size pans. Features adjustable temperature controls with digital read-out and lighted on/off rocker switch. SCR4 is NSF-7 compliant @35° F product temperature utilizing a 1/6-HP compressor, 300 BTUH and R-134A refrigerant, 120V, 60 HZ.

Warranty:

Star’s refrigerated condiment rail is covered by Star’s one year parts & labor warranty.





Star Manufacturing

Self Contained Refrigerated Countertop Server

**STAR® SELF CONTAINED REFRIGERATED COUNTERTOP SERVER
MODEL: RCR4**

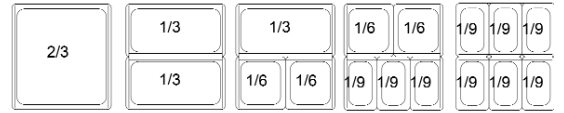
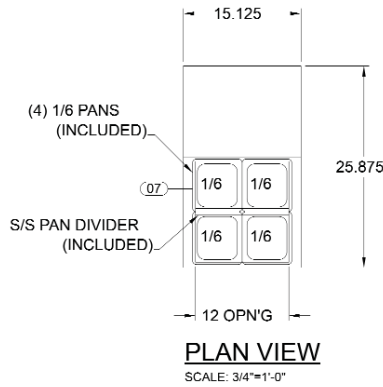

VARIOUS OTHER PAN ARRANGEMENTS
(PANS BY OTHERS)

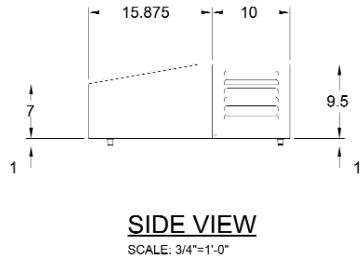

SIDE VIEW
SCALE: 3/4"=1'-0"

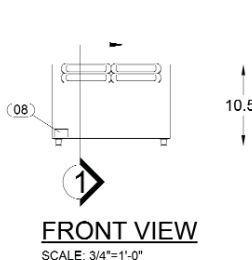

FRONT VIEW
SCALE: 3/4"=1'-0"

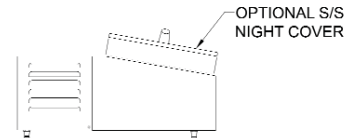

SIDE VIEW
SCALE: 3/4"=1'-0"

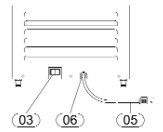

REAR VIEW
SCALE: 3/4"=1'-0"

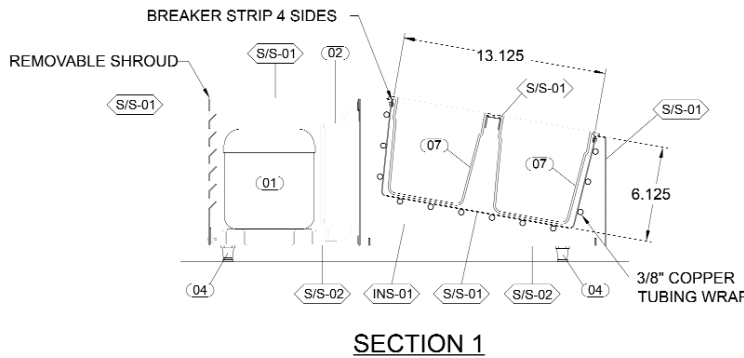

SYMBOL DETAILS

- 01 Compressor; 115V, 60 HZ, 300 BTUH, R-134A
- 02 Temperature Control
- 03 Lighted On/Off rocker Switch
- 04 Adjustable Feet with Rubber Toe
- 05 4' Power Cord with NEMA 5-15P Plug
- 06 Strain Relief
- 07 1/6th Size, 6" deep Poly Carbonate Inset Pans with Hinged Lids
- 08 Logo
- S/S-01 20 Gauge Stainless Steel
- S/S-02 16 Gauge Stainless Steel
- S/S-01 20 Gauge Stainless Steel
- S/S-01 16 Gauge Stainless Steel
- INS-01 Foamed-In-Place Polyurethane Insulation

Model No.	Overall Dimensions Inches mm	Opening Size	Voltage	Watts	HP	Amps	Phase	Power Supply	Refrigerant	Shipping Weight
RCR4	15-1/8"W x 25-7/8"L x 10-1/2"H 384mm x 655mm x 267mm	12" x 12" 305mm x 305mm	120V	240	1/16	2	1	NEMA 5-15P	134A	70 lbs. 33.6 kg

MINIMUM CLEARANCES			
LEFT SIDE	RIGHT SIDE	REAR	BOTTOM
1"	1"	1"	1"
25.4mm	25.4mm	25.4mm	25.4mm



Due to periodic changes in designs, methods, procedures, policies and regulations, the specifications contained in this sheet are subject to change without notice. While Star Manufacturing exercises good faith efforts to provide information that is accurate, we are not responsible for errors or omissions in information provided or conclusions reached as a result of using the specifications. By using the information provided, the user assumes all risks in connection with such use.

Star Manufacturing International Inc. - 10 Sunnen Drive - P.O. Box 430129 - St. Louis, MO 63143-3800
Phone: (314) 678-6303 - FAX: (314) 781-3636 - www.star-mfg.com